



鋭匙鉗子 斎藤氏



10335600
直
a 220 b 245
1/1



10336601 直 円形 2.5 mm
10336602 直 円形 3.0 mm
10336603 直 円形 3.5 mm
a 220 b 245
1/1



10335700
上向
a 220 b 245
1/1



10336501 上向 円形 2.5 mm
10336502 上向 円形 3.0 mm
10336503 上向 円形 3.5 mm
a 230 b 245
1/1



10336801
上向/右開
a 230 b 245



10336201 右曲 円形 2.5 mm
10336301 右曲 円形 3.0 mm
a 220 b 245
1/1



10336803
上向/右開 大
a 220 b 245



10336805
上向/右開 小
a 220 b 245



10336202 左曲 円形 2.5 mm
10336302 左曲 円形 3.0 mm
a 220 b 245
1/1



10336802
上向/左開
a 230 b 245



10336804
上向/左開 大
a 220 b 245



10336806
上向/左開 小
a 220 b 245

1/1

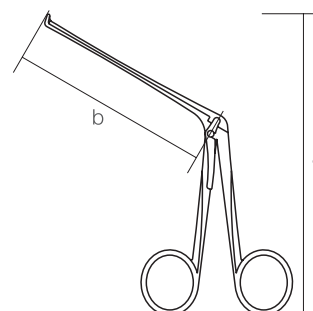



麦粒鉗子 斎藤氏

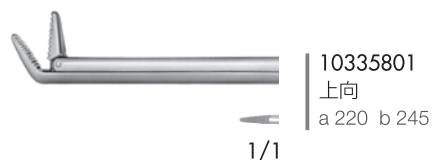
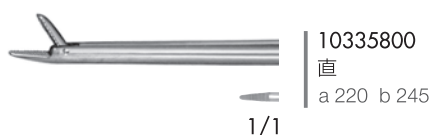

剪刀 斎藤氏

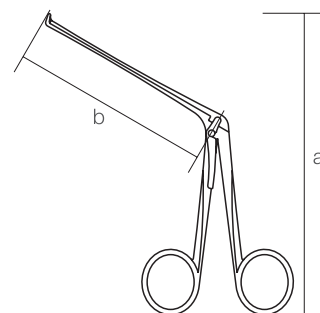



装着図

刀 斎藤氏 梨地

10337500
把柄
斎藤氏

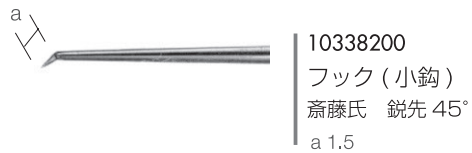
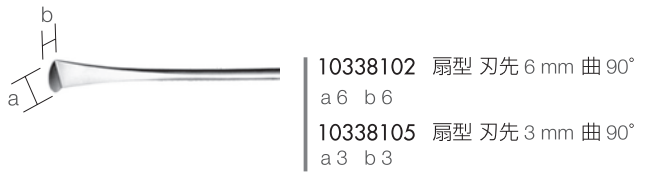
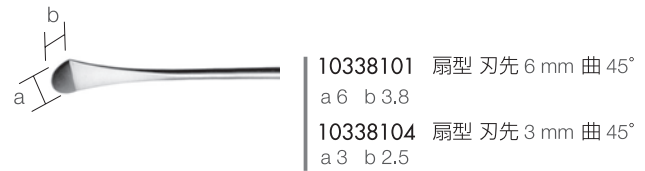
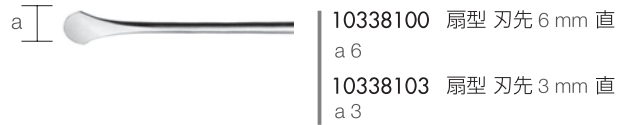

ラリngoマイクロサージャリー

吸引管 ラリngo用

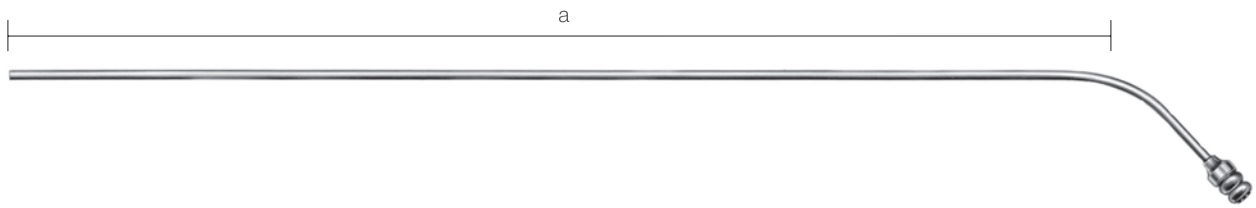

	(外径)	(a)		(外径)	(a)
	1.0	× 300		2.0	× 300
	1.5	× 300		2.5	× 300
	1.8	× 300		3.0	× 300

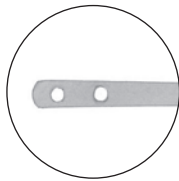
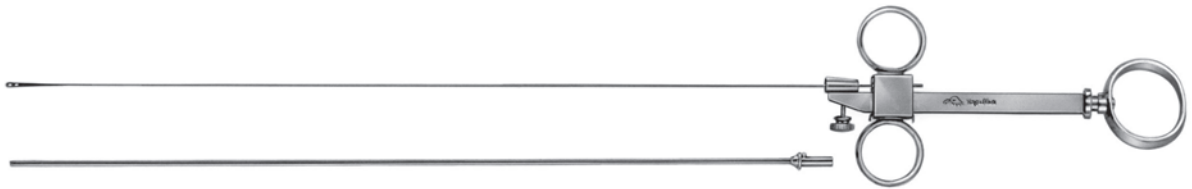

10339300
ラリngo用絞断器
a 250

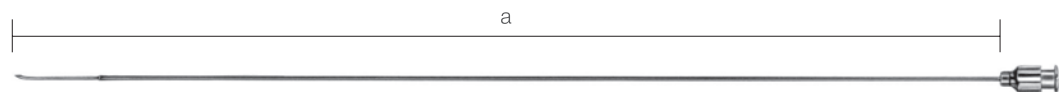

10339200
注射針
ラリngo用 19G
a 265

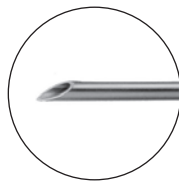

10339201
注射針
ラリngo用 16G
a 265

* 16G と 19G では先端形状が異なります。

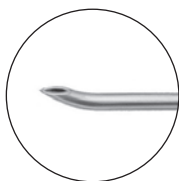

10339203
注射針
牛島氏 ラリngo用 19G
a 265

アテロコラーゲン注射針

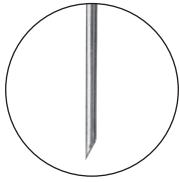
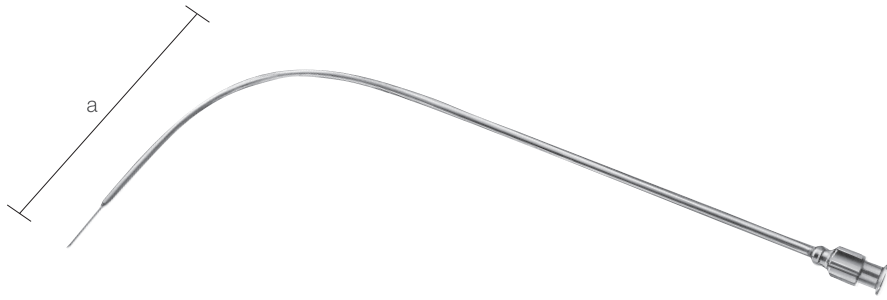

10319701
直
a 80



10319702
左
a 80

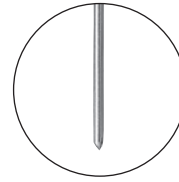

10319703
右
a 80

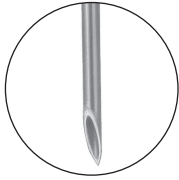

10319800
アテロコラーゲン注入針
田山氏 25G
a 155

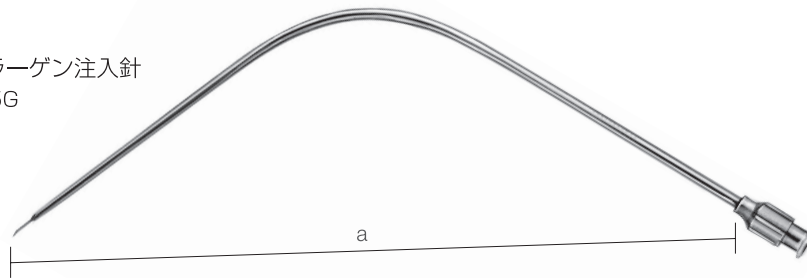

10341400
送糸器
西山氏 ラリソゴ用
全長 270 a 8



10341170
送糸器
角田氏 ラリソゴ用 梨地
全長 270 a 3



10341570
声帯用粘膜炎下剥離子
西山氏 梨地
全長 270



10341270
鈍鈎
角田氏 ラリソゴ用 梨地
全長 270 a 3



10339472
ミラー ラリソゴ用
円/8 mm 梨地
全長 323



10341370
テラメス
角田氏 ラリソゴ用 梨地
全長 270 a 3